

**TECHNICAL DRAWING**

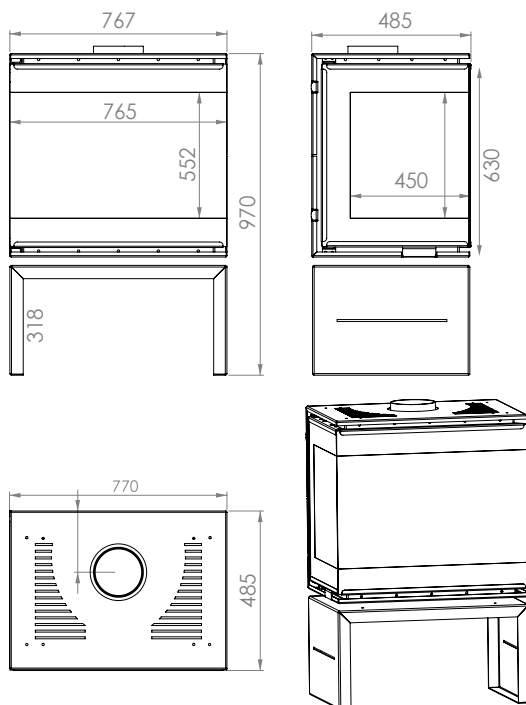

**TECHNICAL SPECIFICATION**

<b>WEIGHT</b>	136 KG
<b>POWER</b>	8-12 KW
<b>EFFICIENCY</b>	>75 %
<b>CONSUME</b>	2 - 3.5 kg/h
<b>FLUE GAS TEMPERATURE</b>	222° C
<b>PIPE DIAMETER</b>	Ø 180 mm
<b>CO</b>	< 1250 mg/m <sup>3</sup>
<b>WARRANTY</b>	5 years

**DIMENSIONS**

Height	970 mm
Depth	485 mm
Width	767 mm